

# M12FID-0 BTY. IMPACT DRIVER XXX

4933459822 - M12FID-0 - 4000467033

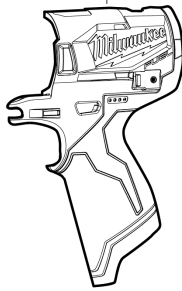

47

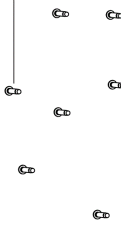
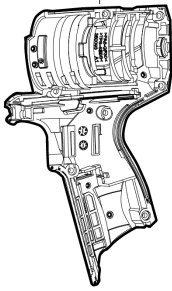

\* While stock lasts

KIT	80	49	50
	60		

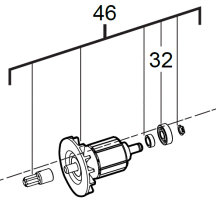

46

32

49\*

44

50\*

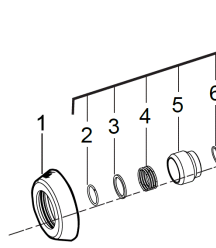

1

2

3

4

5

6

7

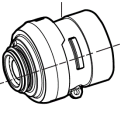

8

9

10

11

40

37

60

48

702

701

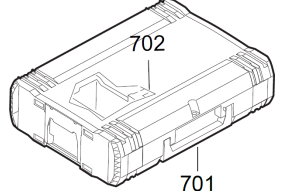

Position	Quantity	Description	Part number	EAN
0001	1	RUBBER CAP	4931465195	4058546232955
0002	1	HOLDING RING	4931440469	4002395892068
0003	1	WASHER	4931466862	4058546280796
0004	1	SPRING	4931440467	4002395892044
0005	1	SLEEVE	4931454722	4058546013394
0006	1	SPRING	4931435385	4002395890019
0007	1	HOLDING RING	4931454723	4058546013400
0008	1	GEAR BOX	5131000000	
0009	1	RING	4931435780	4002395867578
0010	1	BALL	4931440304	4002395891443
0011	1	IMPACT BOLT	4931465197	4058546232979
0032	1	BALL BEARING	681262001	4002395806126
0037	1	LEVER	4931465198	4058546232986
0040	1	CONNECTOR	4931436292	4002395252909
0044	1	IMPACT BOLT	4931465199	4058546232993
0046	1	ARMATURE	4931465201	4058546233013
0047	1	HOUSING	4931465202	4058546233020
0048	1	HOLDER	4931465203	4058546233037
0049	1	GEAR UNIT	5131000000	
0050	1	GEARWHEEL SET	5131000000	
0060	1	RATING PLATE	4931465206	4058546233068
0080	1	GEARING ASSY	4931474363	4058546336882
0702	1	INSERT	4931465207	4058546233075
0701	1	HD Box 1 - 1pc	4932453385	4002395146376

# M12FID-0 BTY. IMPACT DRIVER XXX

4933459822 - M12FID-0 - 4000474345



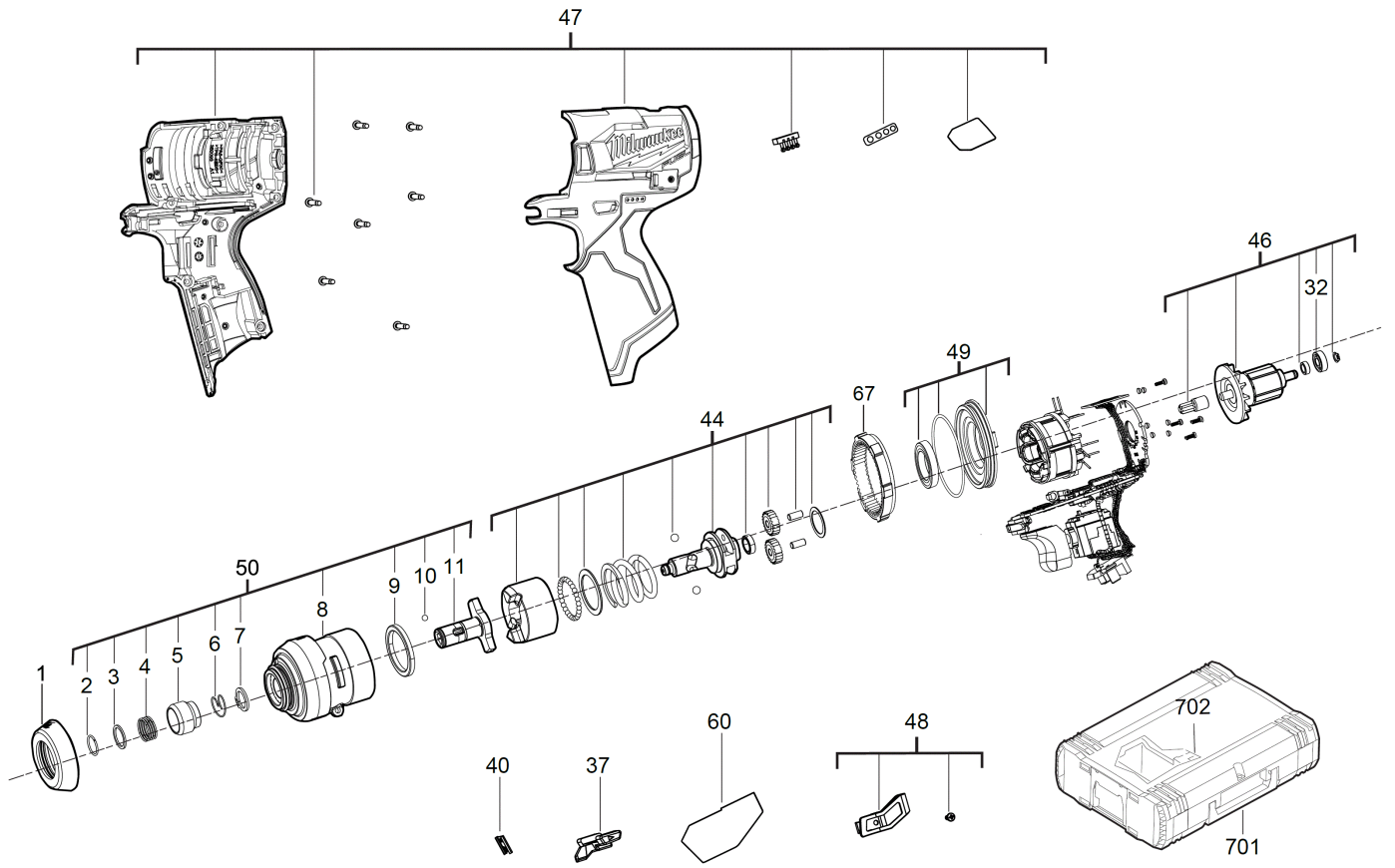

Position	Quantity	Description	Part number	EAN
0001	1	RUBBER CAP	4931465195	4058546232955
0002	1	HOLDING RING	4931440469	4002395892068
0003	1	WASHER	4931466862	4058546280796
0004	1	SPRING	4931440467	4002395892044
0005	1	SLEEVE	4931454722	4058546013394
0006	1	SPRING	4931435385	4002395890019
0007	1	HOLDING RING	4931454723	4058546013400
0008	1	GEAR BOX HOUSING	4931472349	4058546285661
0009	1	RING	4931435780	4002395867578
0010	1	BALL	4931440304	4002395891443
0011	1	IMPACT BOLT	4931465197	4058546232979
0032	1	BALL BEARING	681262001	4002395806126
0037	1	LEVER	4931465198	4058546232986
0040	1	CONNECTOR	4931436292	4002395252909
0044	1	IMPACT BOLT	4931465199	4058546232993
0046	1	ARMATURE	4931465201	4058546233013
0047	1	HOUSING	4931465202	4058546233020
0048	1	HOLDER	4931465203	4058546233037
0049	1	GEAR BOX COVER	4931465692	4058546237929
0050	1	GEAR BOX	4931472350	4058546285678
0060	1	RATING PLATE	4931472351	4058546285685
0067	1	INTERN.GEARED WHEEL	4931472352	4058546285692
0701	1	HD Box 1 - 1pc	4932453385	4002395146376
0702	1	INSERT	4931465207	4058546233075